



INSTALLATION INSTRUCTIONS

Accessory
LIGHT BAR
P/N 08P70-MGS-A30

Application
NC700X/XD

Publication No.
MII 13973
Issue Date
May 2012

Honda Dealer: Please give a copy of these instructions to your customer.

PARTS LIST

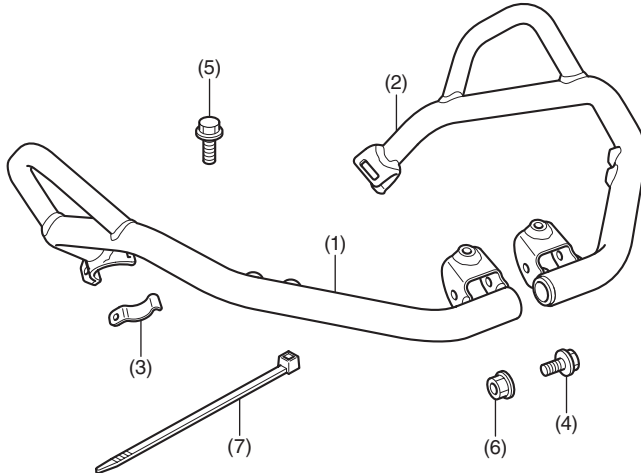

No.	Description	Qty
(1)	Right light bar	1
(2)	Left light bar	1
(3)	Holder	2
(4)	6 mm flange bolt (short)	3
(5)	6 mm flange bolt (long)	2
(6)	6 mm flange nut	3
(7)	Wire tie	1

TOOLS AND SUPPLY REQUIRED

Socket (10 mm)
Ratchet
Box-end wrench (10 mm)
File
Fret saw
Scissors
Marker
Torque wrench

TORQUE CHART

Tighten all screws, bolts, and nuts to their specified torque values. Refer to the Service Manual for the torque values of the removed parts.

Item	N-m	kgf-m	lbf-ft
6 mm flange bolt and nut	12	1.2	9

USE AND CARE INFORMATION

NOTICE:

- **DO NOT GRASP THE LIGHT BAR OR ATTACHED ACCESSORIES TO MOVE THE MOTORCYCLE AS IT MAY DAMAGE THE MOTORCYCLE AND ACCESSORIES.**

NOTE:

- Check the accessory mounts frequently and retighten if necessary.

INSTALLATION

CAUTION:

- To prevent burns, allow the engine, exhaust system, radiator, etc. to cool before installing the accessory.

NOTE:

- Take care not to damage the painted surfaces of the motorcycle.
- Reinstall the removed parts on the motorcycle and make sure that the wires and harnesses are not pinched.
- Trim the excess ends off the wire ties after attaching them to the wire harnesses. Do not allow the cut part of the wire tie to interfere with any wire harness or brake hose.

1. Refer to the Service Manual for the motorcycle, remove the seats.

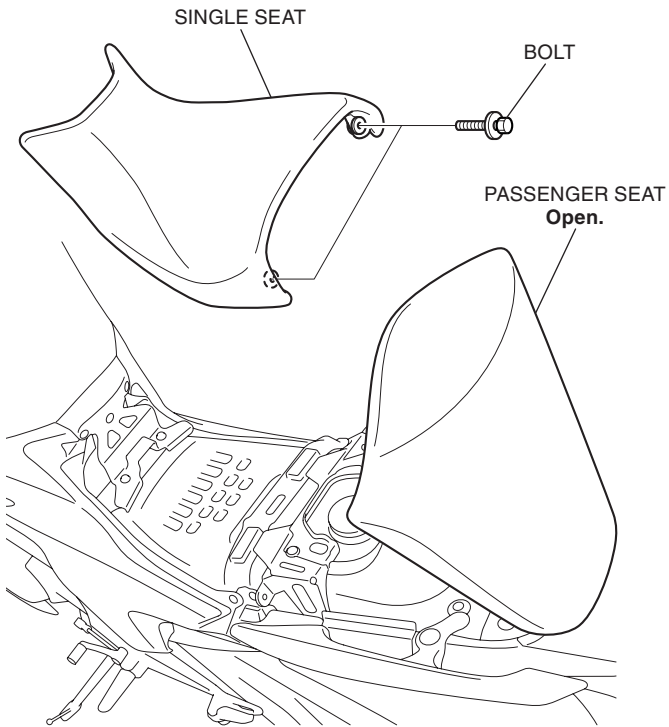

2. Refer to the Service Manual for the motorcycle, remove the left air duct.
 - Repeat on the right side.

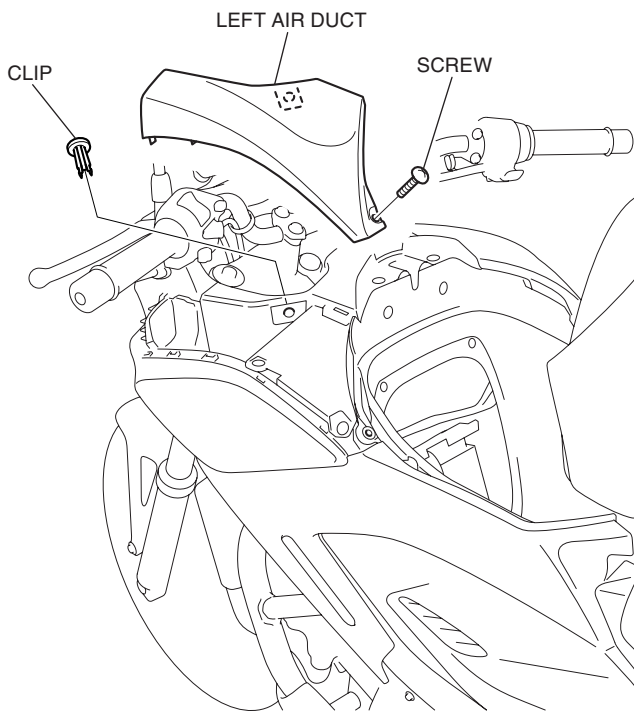

3. Remove the clip and open the front part of the left seat cowl slightly as shown.
 - Repeat on the right side.

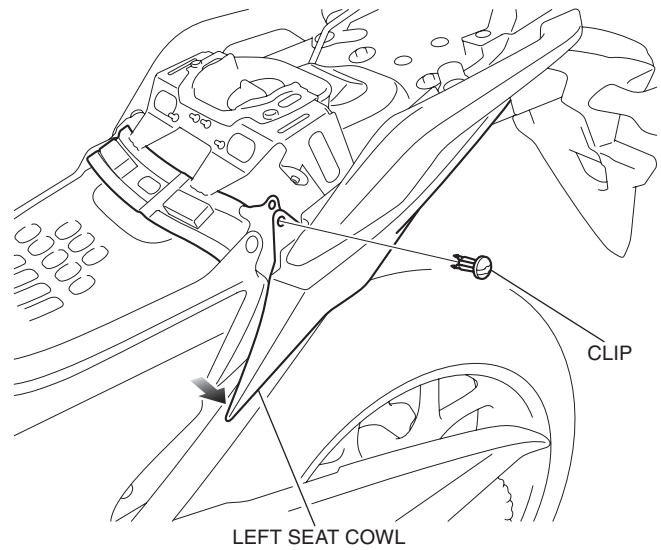

4. Refer to the Service Manual for the motorcycle, remove the left side cover.
 - Repeat on the right side.

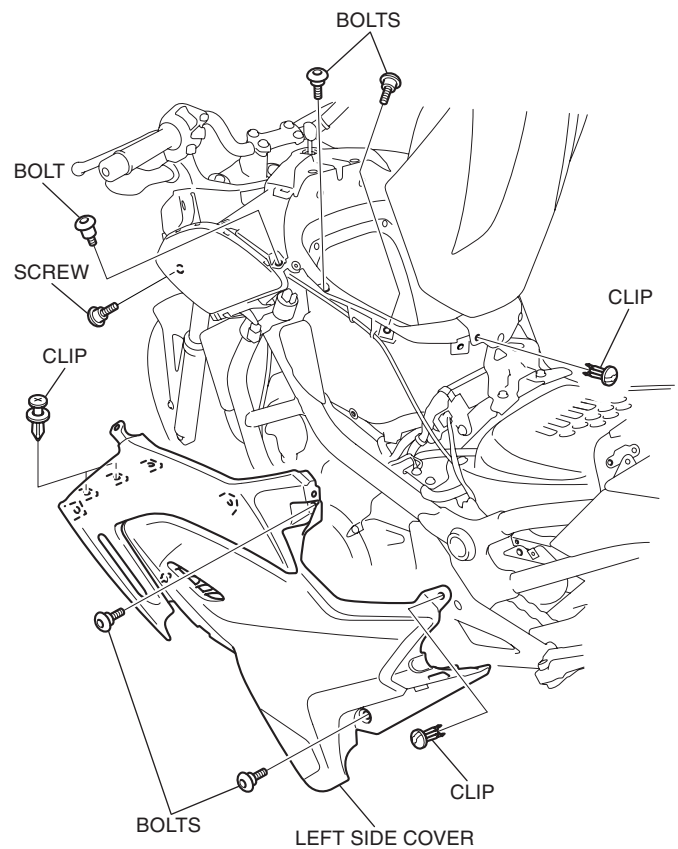

5. Refer to the Service Manual for the motorcycle, remove the front under cover.

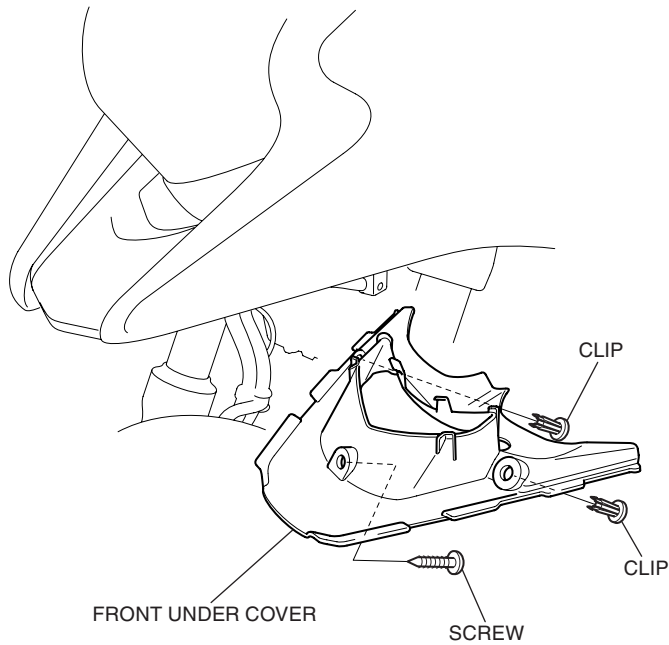

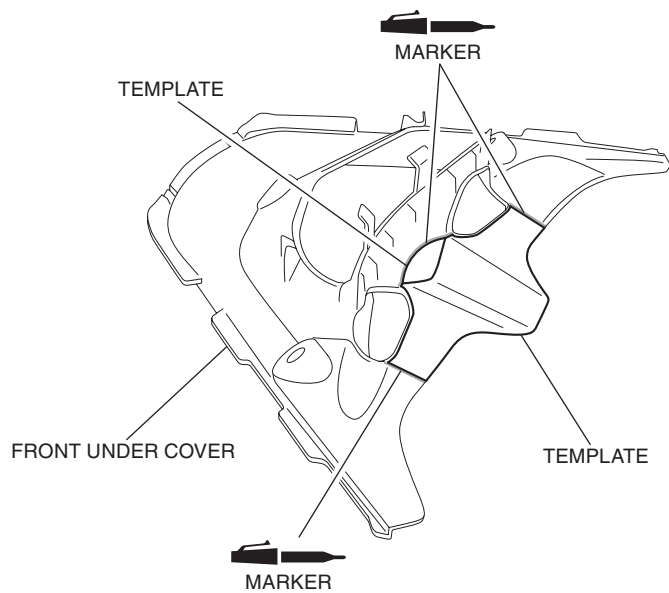

6. Cut and attach the template to the front under cover and mark it using a marker as shown.

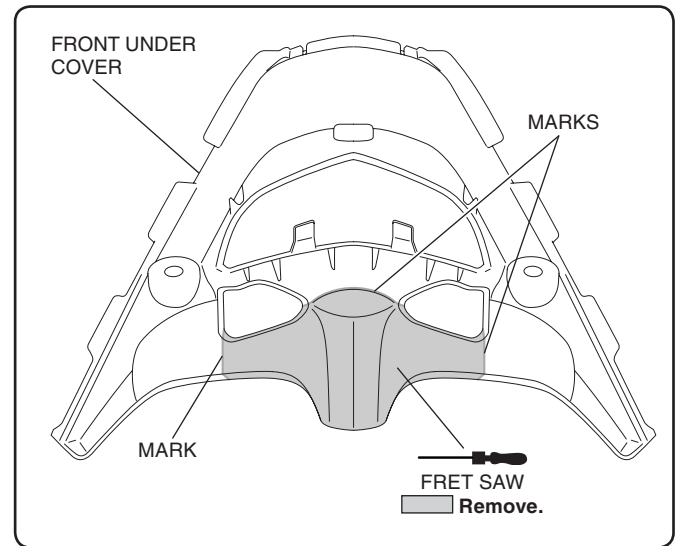

7. Remove the template. Cut away the shaded area of the front under cover as shown.
- Remove any burrs.



 FILE
File off the cut surfaces after removing the  area.

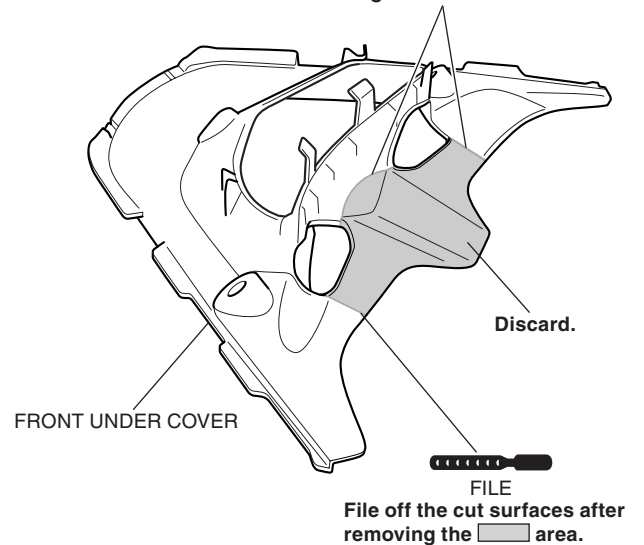

8. Install the front under cover in the reverse order of removal.

9. Assemble the left light bar as shown.

- Repeat on the right side.

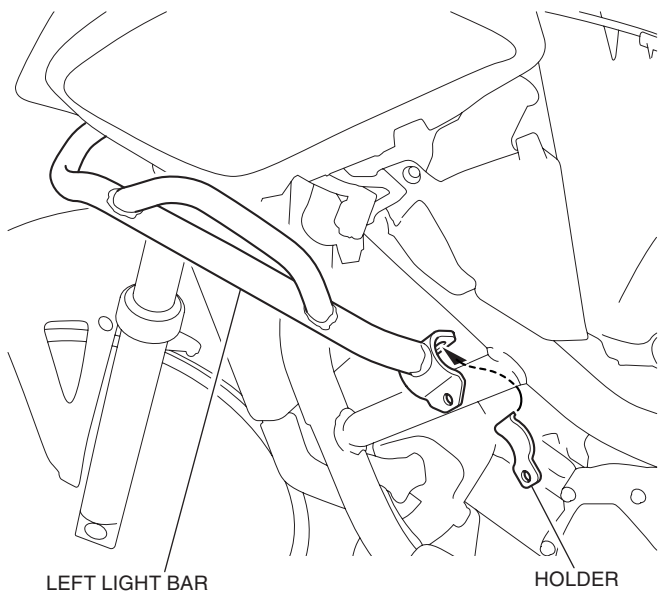

10. Move the left light bar with the holder forward as shown.

- Be careful not to scratch the frame.
- Repeat on the right side.

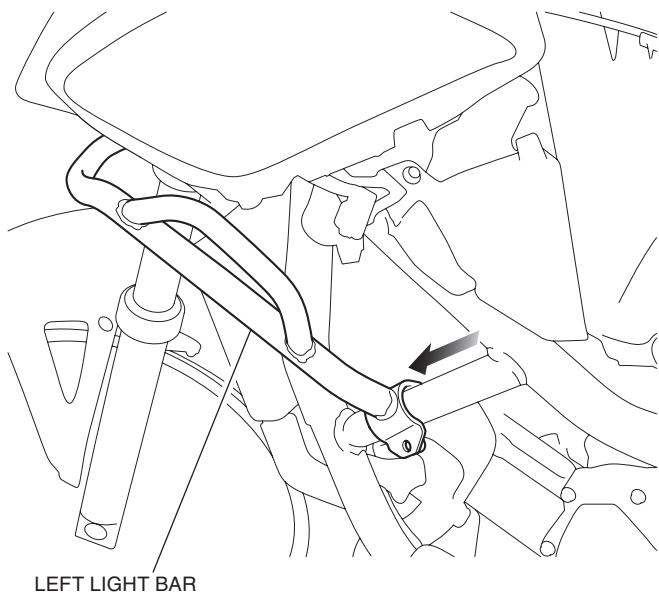

11. Install the removed parts in the reverse order of removal.

- Confirm that any wire harness is not caught or too tight.

12. Assemble the right and left light bars as shown.

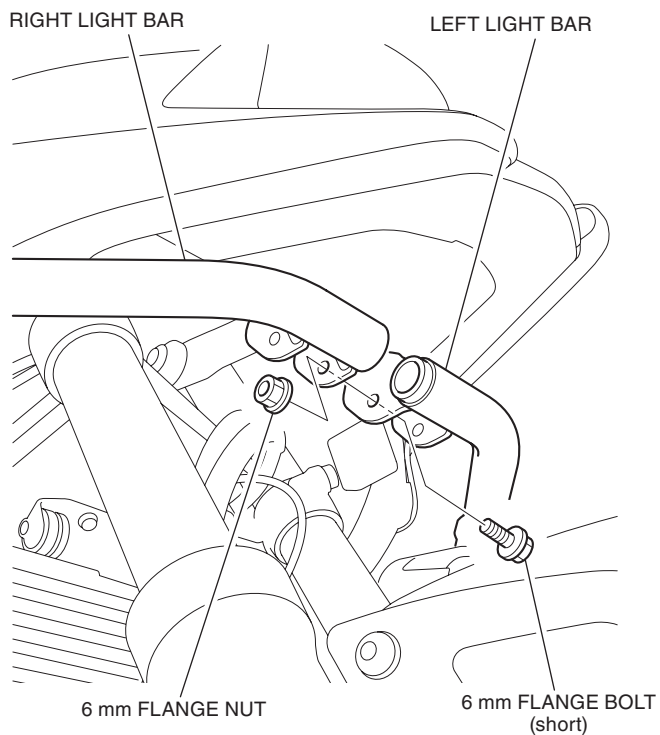

13. Move the light bars with the holders rearward as shown.

- Be careful not to scratch the frame.
- Repeat on the right side.

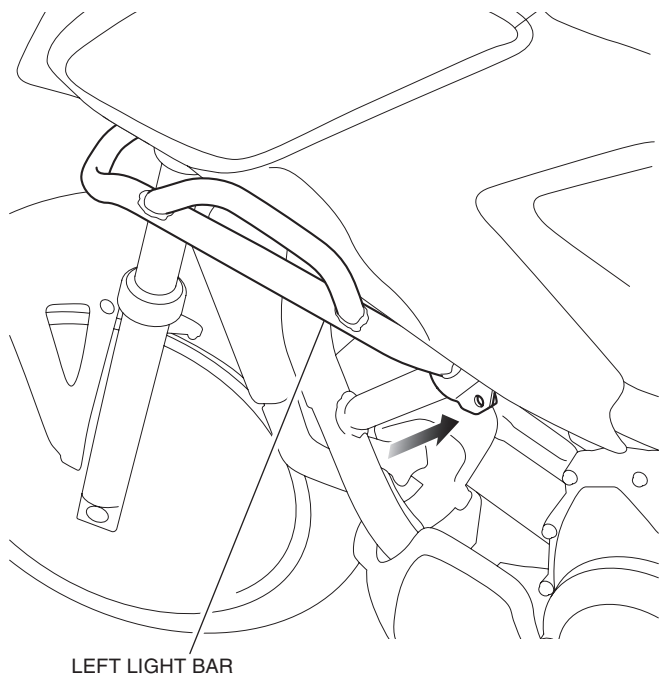

14. Loosely install the 6 mm flange bolts and nuts as shown.

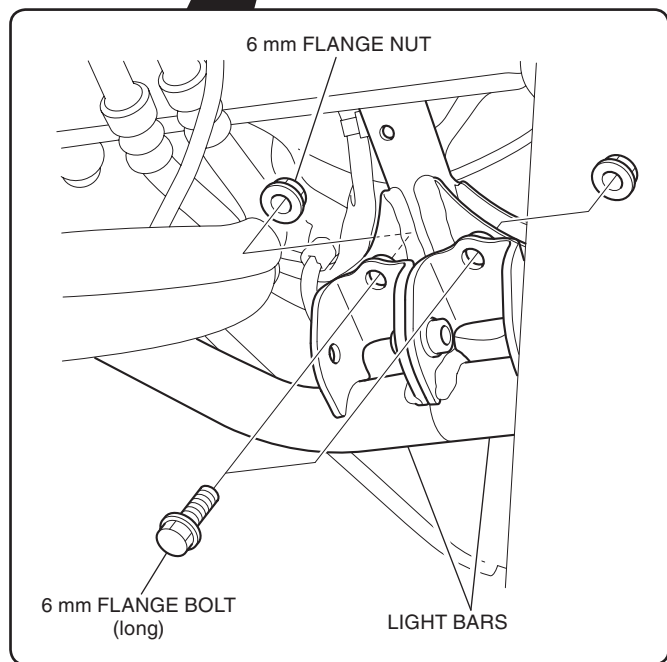
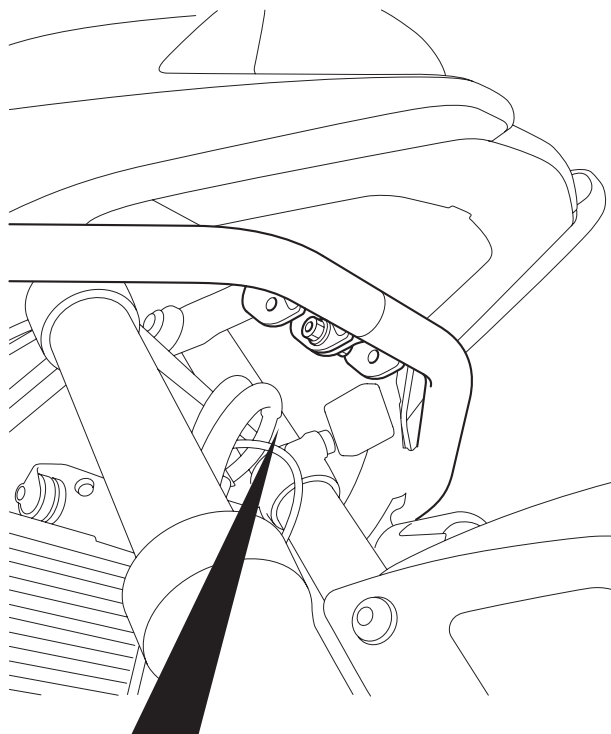

15. Loosely install the 6 mm flange bolt as shown.

- Repeat on the right side.

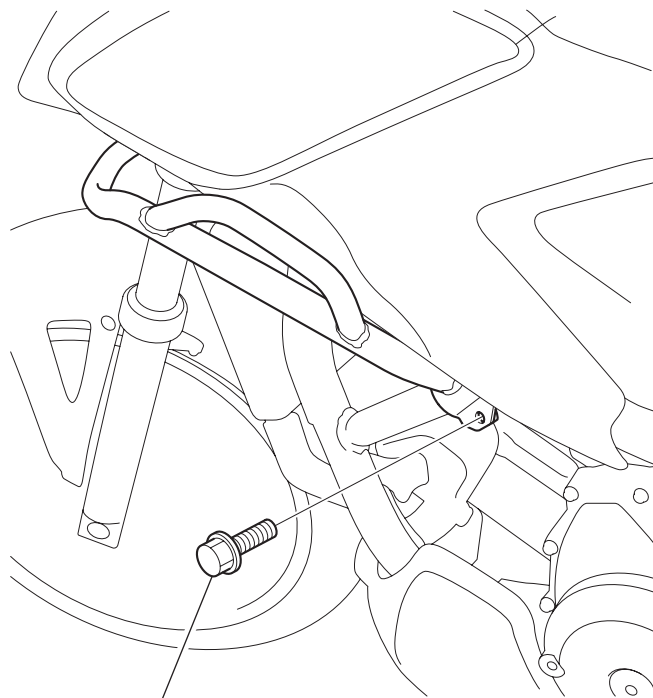

6 mm FLANGE BOLT
(short)

16. Tighten all loosely installed hardware to the specifications in the torque chart.

17. Secure the motorcycle's horn wire with the wire tie as shown.

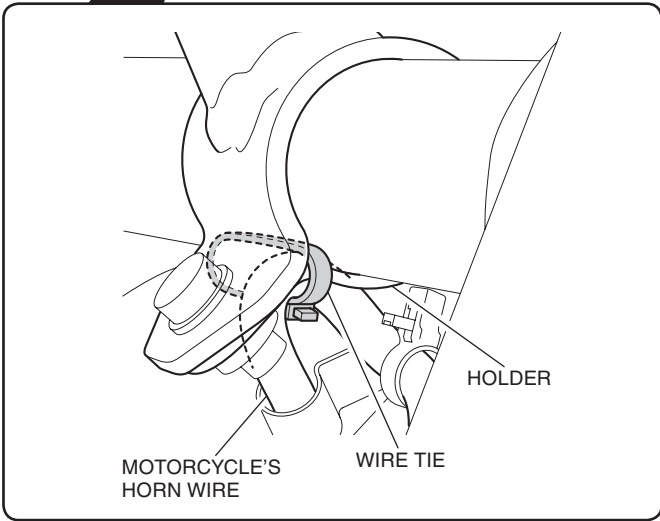
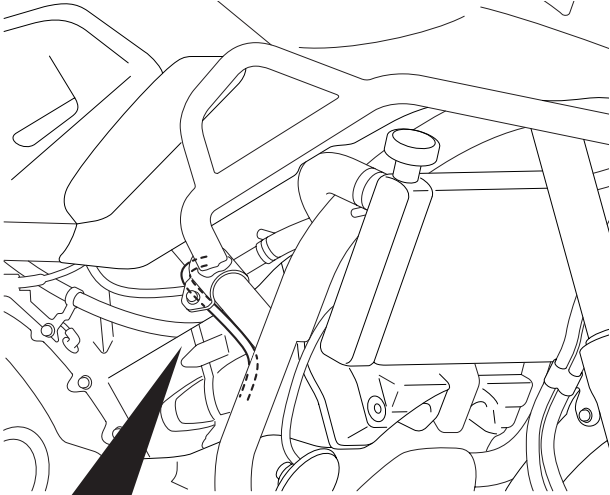

<TEMPLATE>

Cut off along the dotted line.

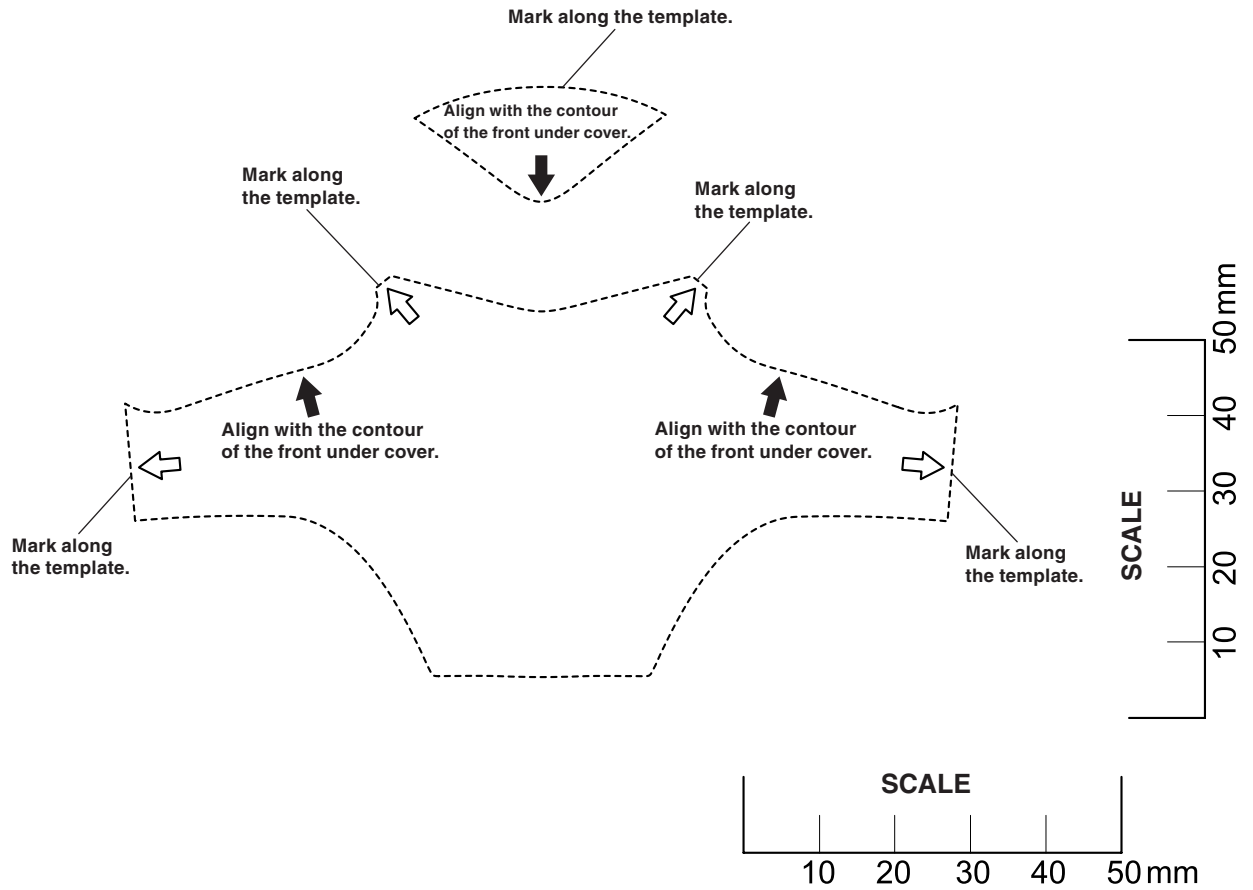

NOTICE

If you print this template from your local computer, make sure the printer settings do not “scale” or “shrink” the page.